

FUSE

As illustrated in Fig.4-19 , the fuse box (1) is located in the battery compartment. The main fuse, main fuse (electric shift motor), sub fuses and spare fuses are located in the fuse box.

The specified main fuse is:

30 A , 30 A (Electric shift motor)

The specified sub fuses are:

15 A × 2, 10 A × 2

If a fuse fails frequently, it usually indicates a short circuit or an overload in the electrical system. See your authorized Honda dealer for repair.

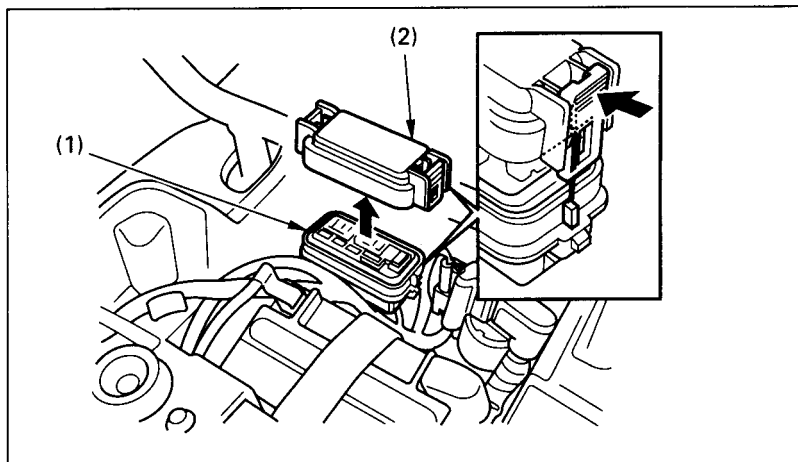

Fig. 4-19

(1) Fuse box
(2) Fuse box cover

To replace the main fuse:

1. Make sure the ignition switch is OFF (○).

CAUTION:

Turn the ignition switch OFF (○) before checking or replacing the fuse to prevent accidental short-circuiting which could damage the electrical system.