

Clutch System

Your ATV's shift-activated, wet, multiplate clutch is part of the primary drive system. Proper adjustment allows a smooth, gradual engagement when shifting gears.

Clutch Adjustment

Refer to *Safety Precautions* on page 91.

FRONT

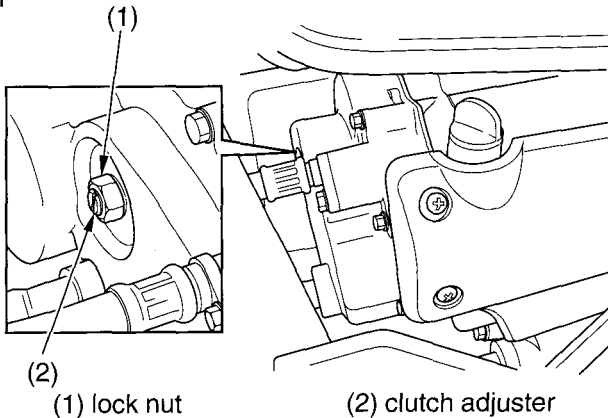

1. Make sure the ignition switch is OFF (\bigcirc).
2. Loosen the lock nut (1).
3. Turn the clutch adjuster (2) counterclockwise until you feel slight resistance.
4. Turn the adjuster 1/4 turn clockwise, then tighten the lock nut to hold the adjuster in this position.
5. After adjustment, start the engine and test ride your ATV to be sure the clutch is operating properly.

If you cannot get proper adjustment, or the clutch does not work properly, the clutch friction discs may be worn. See your Honda dealer or refer to official Honda Service Manual (page 214).