

Clutch System

Reverse Lock System Adjustment

Refer to *Safety Precautions* on page 91 .

LEFT HANDLEBAR

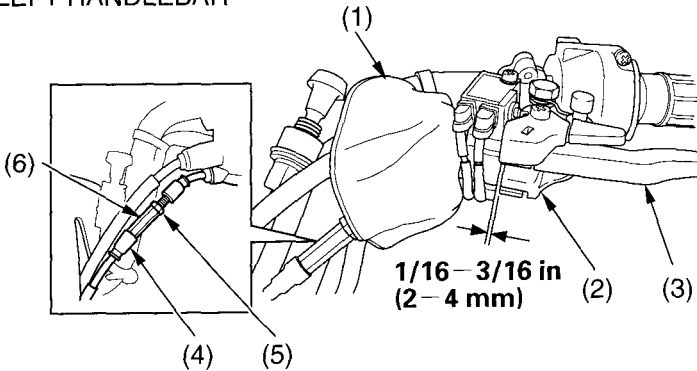

- | | |
|--------------------------|-------------------|
| (1) dust cover | (4) rubber sleeve |
| (2) reverse assist lever | (5) lock nut |
| (3) rear brake lever | (6) adjusting nut |

1. Turn over the dust cover (1).
2. Check the reverse assist lever (2) freeplay, measured at the rear brake lever (3) end near the cable:
 $1/16 - 3/16$ in (2 - 4 mm)
3. To adjust, slide the rubber sleeve (4), loosen the lock nut (5) and turn the adjusting nut (6).
After adjustment, tighten the lock nut securely.
4. Return the dust cover and rubber sleeve.

Other Checks

Check the reverse assist lever and cable for loose connections or other damage. If the cable is worn or kinked, have it replaced by your Honda dealer.