

Suspension

6. Pour the recommended fork oil (page 91) into the outer tube (3).

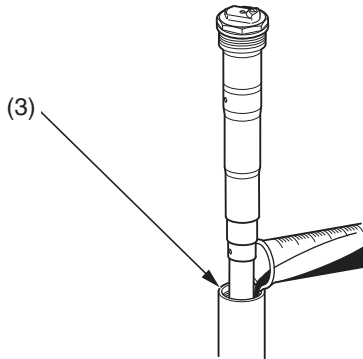

(3) outer tube

Right Fork Oil Capacity:

Standard oil capacity	11.7 US oz (347 cm ³)
-----------------------	-----------------------------------

Approximately 0.2 US oz (7 cm³) of fork oil remains after draining. This amount must be noted when filling to the standard oil capacity.

7. Check that the O-ring (10) on the fork damper (4) is in good condition. Apply the recommended fork oil to the O-ring. Temporarily install the fork damper to the outer tube (3). After installing the fork leg (page 107), tighten the fork damper to the specified torque using a lock nut wrench:
- Actual:
56 lbf·ft (76 N·m, 7.7 kgf·m)
Torque wrench scale reading:
51 lbf·ft (69 N·m, 7.0 kgf·m), using a 20 in (50 cm) long deflecting beam type torque wrench.

When using the lock nut wrench, use a 20 in (50 cm) long deflecting beam type torque wrench with a lock nut wrench. The lock nut wrench increases the torque wrench's leverage, so the torque wrench reading will be less than the torque actually applied to the fork damper.

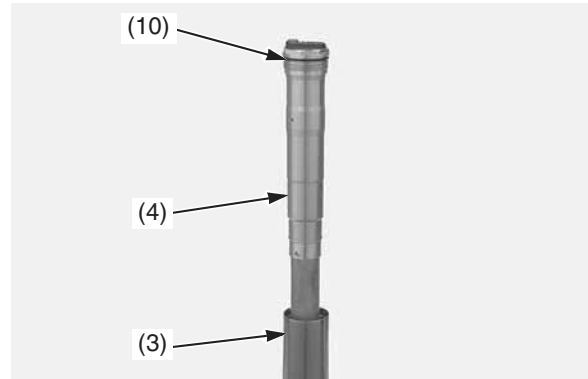

(3) outer tube
(4) fork damper
(10) O-ring

8. Clean the threads of the fork protector socket bolts (1) and axle holder thoroughly. Apply locking agent to the bolt threads. Install the fork protector (2) and fork protector socket bolts. Tighten the fork protector socket bolts to the specified torque:
5.2 lbf·ft (7 N·m, 0.7 kgf·m)

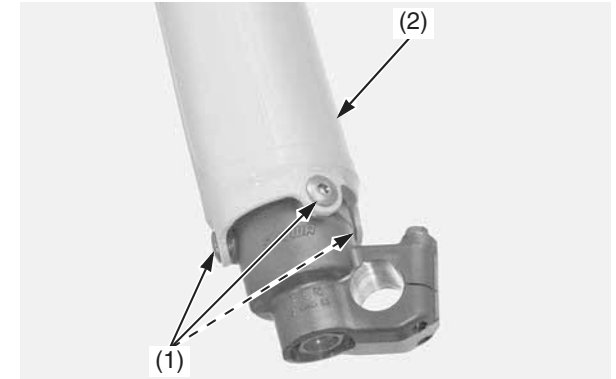

(1) fork protector socket bolts
(2) fork protector