

Owner's Manual Storage

Your ATV provides storage for the owner's manual so you'll have it with you for easy reference. Store your owner's manual (1) in the storage compartment (2) under the seat.

To access the owner's manual, remove the seat (see page 84), then remove the rubber band (3), and open the plastic cover (4).

Make sure the owner's manual and tool kit are fastened securely with the rubber band.

Be careful not to flood this area when washing your ATV.

REAR

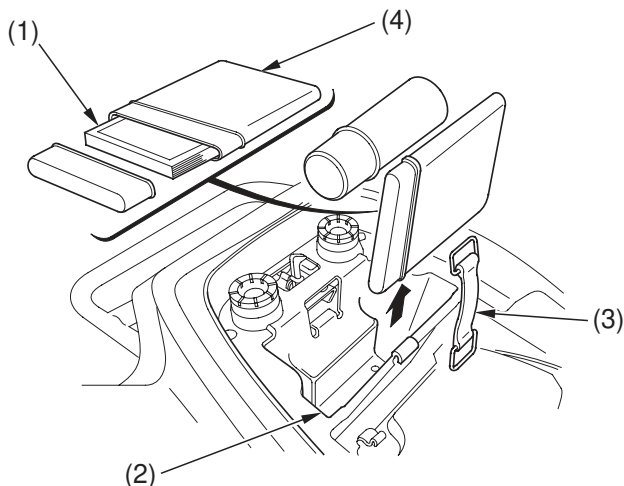

(1) owner's manual
(2) storage compartment

(3) rubber band
(4) plastic cover