

Drivetrain Boots

Refer to *Safety Precautions* on page 121.

FRONT

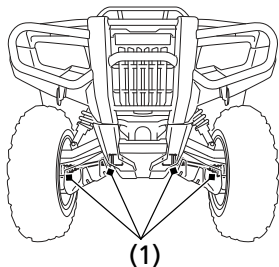

REAR

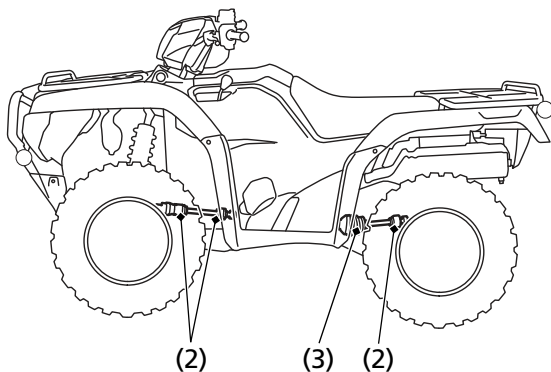
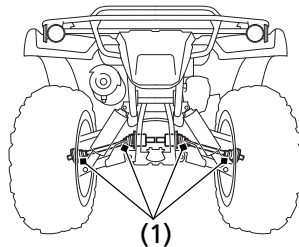

- (1) rubber driveshaft boots (2) rubber propeller shaft boots
(3) rubber yoke joint boot

Check the rubber driveshaft boots (1), rubber propeller shaft boots (2) and rubber yoke joint boot (3) for cuts, damage or leaking grease. If necessary, have your dealer replace them.